

Link do produktu: <https://factory-outlet.pl/wspornik-do-klimatyzatora-z-poprzezka-icool-hl-550-p-1225.html>

Wspornik do klimatyzatora z poprzeczką ICOOL HL-550



Cena	59,00 zł
Numer katalogowy	NR-WSP-550
Kod producenta	NR-WSP-550
Kod EAN	5905973501064
Marka	Entalpia Europe
Rodzaj	wsporniki
EAN (GTIN)	5905973501064
Waga produktu z opakowaniem jednostkowym	7
Kod producenta	NR-WSP-550

Opis produktu



STAN TOWARU: NOWY, STAN TECHNICZNY I WIZUALNY BARDZO DOBRY, ZESTAW KOMPLETNY, DOKŁADNY STAN TOWARU ORAZ JEGO WYPOSAŻENIE ZOSTAŁ UKAZANY NA REALNYCH ZDJĘCIACH NASZEJ AUKCJI, INSTRUKCJA OBSŁUGI BEZ JĘZYKA POLSKIEGO, OPAKOWANIE ORYGINALNE ZE ŚLADAMI MAGAZYNOWANIA.

CENA KATALOGOWA : 79zł

OSTATNIE ZDJĘCIA POKAZUJĄ STAN FAKTYCZNY I WYPOSAŻENIE TOWARU.

Wspornik do klimatyzatora z poprzeczką ICOOL HL-550

DANE TECHNICZNE:

- Uniwersalny wspornik do klimatyzacji
- Wodoodporna, malowana proszkowo powierzchnia
- Udźwig: 150kg

HL-550 z ramieniem o długości 55 cm zalecany jest do montażu wraz jednostkami o mocy 2,5kW, 3,5kW, 5,0kW, 7,0kW

Wspornik sprzedawany wraz z podkładkami antywibracyjnymi oraz kompletem śrub montażowych.

Odpowiedni oraz regulowany rozstaw ramion gwarantuje bezproblemowy i szybki montaż, a poprzeczka umożliwi precyzyjne wypoziomowanie urządzenia.

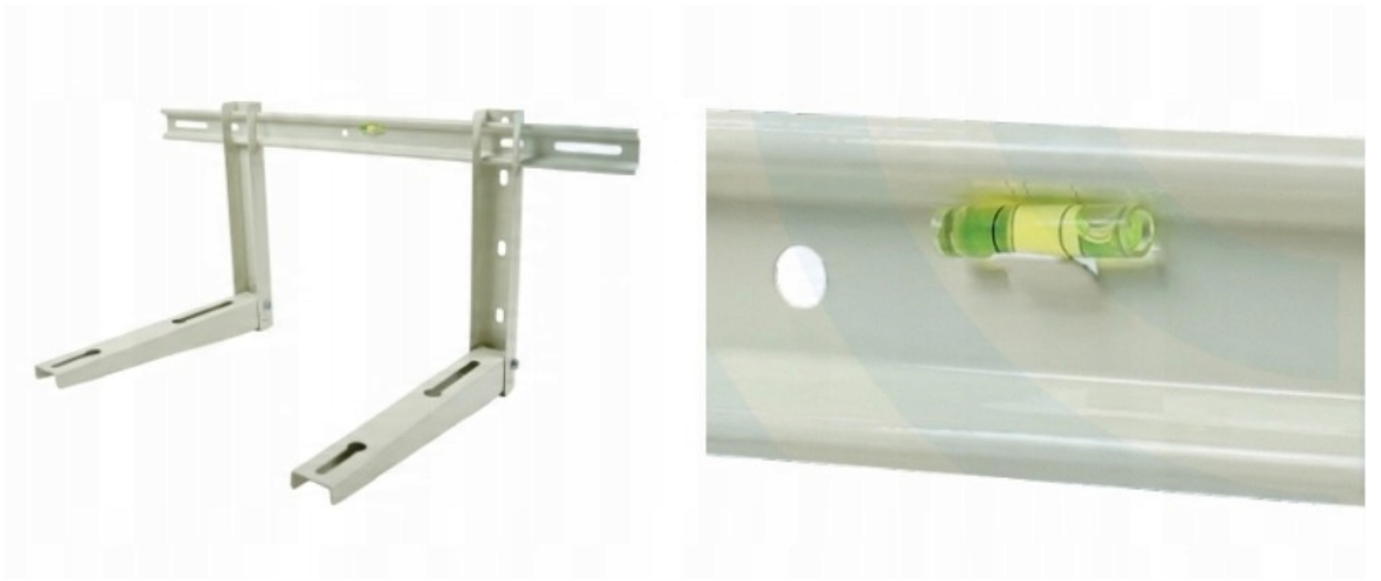













ICOOOL INSTRUCTIONS OF MINI SPLIT BRACKET MODEL HL-550

ICOOOL offers you a high quality, durable and weather resistant mini split wall mounting bracket. The bracket is capable of holding up to 330 LBS, which can be used for universal ductless mini split air conditioners, heat pumps, compressors, and HVAC systems. It is easy and quick to assemble and install.

								
A	B	C	D	E	F	G	H	I
M8	M6	Ø16	Ø24	Ø38	M8	M6	M17	8x75
X4 ✓	X2 ✓	X8 ✓	X4 ✓	X4 ✓	X4 ✓	X2 ✓	X2 ✓	X4 ✓

NOTE: Refer to the figure, confirm that you have received all of the hardware shown, and check for damage or breakage.

INSTALLATION INSTRUCTIONS:

Select a place on the wall where you want to install the compressor. Ensure it is free of obstructions which would interfere with proper compressor operation.

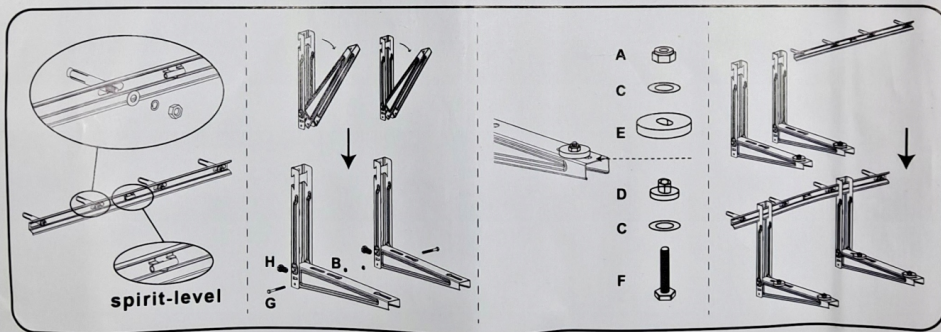

Assembly Steps

- Use spirit-level to correct mounting position of the whole beam. Mark the position where concrete anchors are installed. Drill 2.16" deep holes, punch four concrete anchors and lag bolts into pre-holes, make sure the end of the concrete anchors are flush with the wall surface. Mount the beam with flat washers, lock washers and nuts.
- Unfold the combined horizontal and vertical arms, install angle regulators into the holes at the bottom of the vertical arms, assemble the reinforcing screws.
- Mount anti-vibration pads on the brackets that vertical to the wall.
- Snap the two vertical and horizontal arms in the beam fastened on the wall

! WARNINGS
 Small parts NOT for children under 3 years
 Always take care and select correct type and size of tools to work

ASSEMBLY INSTRUCTIONS

